

ZANUSSI

WASHER-DRYER ZJD 1285

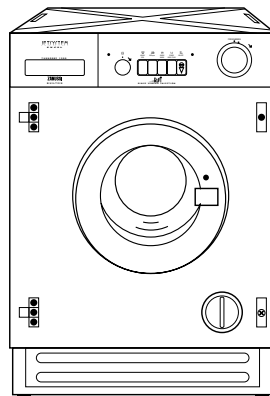

Important Safety Information

It is most important that this instruction book should be retained with the appliance for future reference. Should the appliance be sold or transferred to another owner, or should you move house and leave the appliance, always ensure that the book is supplied with the appliance in order that the new owner can get to know the functioning of the appliance and the relevant warnings.

These warnings have been provided in the interest of safety. You **MUST** read them carefully before installing or using the appliance.

Installation

- This appliance is heavy. Care should be taken when moving it.
- It is dangerous to alter the specifications or attempt to modify this product in any way.
- All packing and transit bolts must be removed before use. Serious damage can occur to the product and to property if this is not adhered to. See relevant section in instructions.
- Any plumbing work required to install this appliance should be carried out by a qualified plumber or competent person.
- Any electrical work required to install this appliance should be carried out by a qualified electrician or competent person.
- Care must be taken to ensure that the appliance does not stand on the electrical supply cable.
- If the machine is situated on a carpeted floor, please adjust the feet in order to allow air to circulate freely.

Child Safety

- This appliance is designed to be operated by adults. Children should not be allowed to tamper with the controls or play with the product.
- Pets and children have been known to climb into washer-dryers. Please check your drum before use.
- The glass door becomes very hot during the washing and drying cycle. Keep children away from the vicinity of the appliance whilst it is in operation.
- Keep all packaging well away from children.
- Keep all detergents in a safe place out of children's reach.

Use

- Always unplug the appliance and turn off the water supply after use.
- Do not overload the appliance. See relevant section in the instruction book.
- Only wash and dry fabrics which are designed to be machine washed and dried. If in doubt, consult the care label on the clothes.



- Before washing, ensure that all pockets are empty and buttons and zips are fastened. Avoid washing frayed or torn articles and treat stains such as paint, ink, rust, and grass before washing. Underwired bras must **NOT** be machine washed.
- Any objects such as coins, safety pins, nails, screws, stones or any other hard, sharp material can cause extensive damage and must not be placed into the machine.
- Garments which have been in contact with volatile petroleum products should not be machine washed. If volatile cleaning fluids are used, care should be taken to ensure that the fluid is removed from the garment before placing in the machine.
- The users should always check that they have not left their gas lighters (disposable or otherwise) in their clothing.
- Never tumble dry items that have had contact with chemicals such as dry cleaning fluid. These are of a volatile nature and could cause an explosion. Only tumble dry items which have been washed in water or require airing.
- Plastic detergent dispensers should not remain in the drum during the drying cycle, as the plastic used is not designed to withstand the heat. If you wish to wash-through-to-dry you should use the conventional detergent dispenser drawer.
- Wash small items such as socks, laces, washable belts etc in a washing bag or pillow case as it is possible for such items to slip down between the tub and the inner drum.
- Only use the advised quantities of fabric softener. Damage to the fabric can ensue if you over-fill. Refer to the manufacturer's recommendations of quantities.
- As some duvets and eiderdowns should be washed/dried in large commercial machines because of their bulk, please check with the manufacturer of the item before washing in a domestic machine.
- Leave the porthole door slightly ajar between washes to preserve the door seal.
- Under no circumstances should you attempt to repair the machine yourself. Repairs carried out by inexperienced persons may cause injury or serious malfunctioning. Contact your local Zanussi Service Force Centre. Always insist on genuine Zanussi spare parts.

Contents

For the User		
Important Safety Information	2	
Your New Washer-Dryer	4	
Description of the Appliance	5	
• Door locked pilot light	5	
• Detergent dispenser drawer	5	
The Control Panel	6	
Operating sequence	7-10	
• Washing 4.5 kg of white cotton at 95°C	7	
Load the laundry	7	
Measure out the detergent	7	
Measure out the fabric softener	7	
Select the required option(s)	7	
Select the required programme	7	
Start the machine	8	
At the end of the programme	8	
• Washing 2 kg of mixed fabrics at 50°C	8	
Load the laundry	8	
Measure out the detergent	8	
Measure out the fabric softener	8	
Select the required option(s)	9	
Select the required programme	9	
Start the machine	9	
At the end of the programme	9	
• Drying 2.25 kg of cotton	10	
Load the laundry	10	
Select the programme	10	
Select the required time	10	
Start the machine	10	
At the end of the programme	10	
• Autodrying 1 kg of mixed fabrics	11	
Load the laundry	11	
Measure out the detergent and fabric softener	11	
Select the programme	11	
Select the required option	11	
Select the required time	11	
Start the machine	11	
At the end of the programme	11	
Washing Hints	12-13	
• Which detergent?....	13	
• And in which form?	13	
Drying Hints	14	
Wash Care Symbols	15	
Washing Programmes	16-17	
Drying Programmes	18	
Maintenance and Cleaning	19-20	
• Descaling	19	
• After each wash	19	
• External cleaning	19	
• Cleaning the dispenser drawer	19	
• Cleaning the drawer recess	19	
• Cleaning the filter	19	
• The dangers of freezing	20	
• Maintenance Wash	20	
Something Not Working	21-22	
Service and Spare Parts	22	
Zanussi Guarantee Conditions	23	
Zanussi Service Force	24-25	
For the Installer		
Installation Instructions	26	
Technical Specifications	26	
• Unpacking	27	
• Positioning	27	
• Water inlet	27-28	
• Water drainage	28	
• Levelling	29	
• Special conditions	29	
• In the interest of the environment	29	
• Electrical connection	30	
• Building-in	31-32	

Guide to use the Instruction Book

The following symbols will be found in the text to guide you throughout the instructions:

-  Safety instructions
-  Hints and tips
-  Environmental information

Your New Washer-Dryer

Your new washer-dryer, fitted with the Zanussi “JET SYSTEM”, meets all modern requirements for effective treatment of laundry with low water, energy and detergent consumption.

Even small loads are washed “economically” because the amount of water used is regulated automatically according to the load and type of fabric.

- **Automatic cooling of the wash water to 60°C** before draining, with the 95°C programme. This reduces thermal shock to fabrics, helping to prevent creasing.
- **The special wool programme** with its new delicate wash system treats your woollens with extreme care.
- **The drying programmes** will enable you to have dry and soft laundry in a short time.

Ecological hints

To save water and energy and help protect the environment, we recommend that you follow these hints:

- The machine works more economically if it is fully loaded (for both washing and drying cycles).
- Adjust the quantity of detergent according to the hardness of your water supply, the amount of laundry and the degree of soiling.
- A programme without prewash is sufficient for normally soiled laundry.
- With adequate pre-treatment, stains and limited soiling can be removed; the laundry can then be washed at a lower temperature.
- Select a “quick” programme for lightly soiled laundry.
- The machine will consume less energy if the laundry is **adequately spun** before being dried.

In the interest of the environment

- Materials marked with the symbol  are recyclable.
- Check with your local Council or Environmental Health Office to see if there are facilities in your area for re-cycling this appliance.
- When the appliance is to be scrapped, cut off the power supply cable and make the door lock device unusable to prevent young children from being trapped inside.
- Help to keep your country tidy - use authorised disposal sites for your old appliance.

How do we help to protect the environment? We use recycled paper!

Important

Your machine is fitted with a balance control device, which ensures the machine is stable during the spin. If the wash load appears not to have been spun sufficiently at the end of the wash cycle, because it is not evenly distributed in the drum, the balance control device may have operated. It will therefore be necessary to redistribute the wash load manually and select a spin programme. For more detailed information see the section headed "Something Not Working".

Description of the Appliance

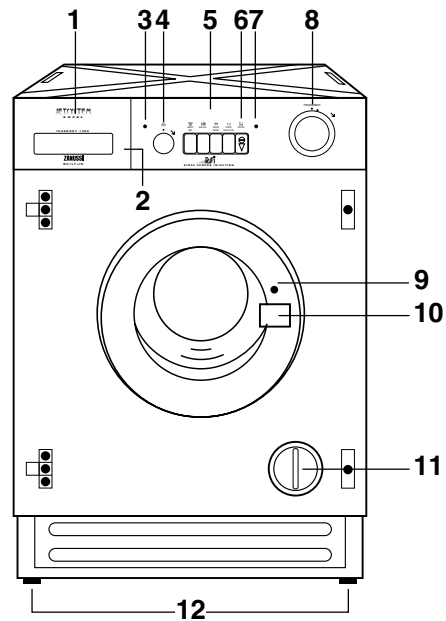

- 1 Detergent dispenser drawer
- 2 Programme guide
- 3 "Drying indicator" light
- 4 Drying time selector dial
- 5 "Option" buttons
- 6 ON/OFF button
- 7 "Mains-on" light
- 8 Programme selector dial
- 9 Door locked pilot light
- 10 Door opening handle
- 11 Filter
- 12 Adjustable feet



Door locked pilot light

The door stays locked throughout the wash cycle. Locking is indicated by a pilot light located next to the door handle. The door cannot be opened until the pilot light has gone out.

Detergent dispenser drawer

-  Prewash
-  Main wash
-  Fabric softener

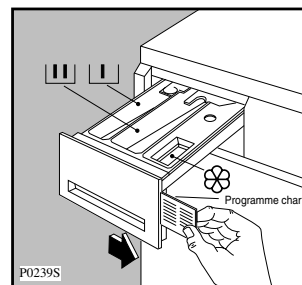

The Control Panel

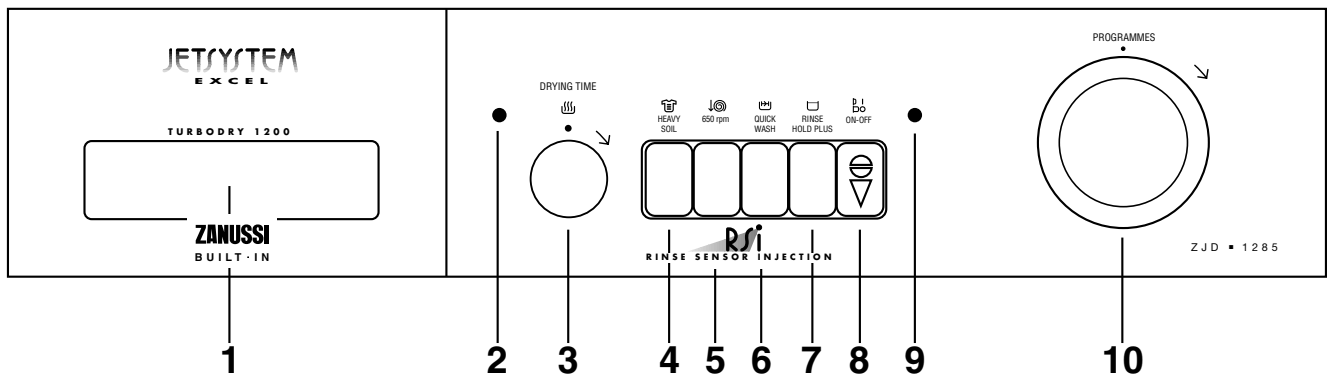

1 Detergent dispenser drawer

2 Drying indicator light

This light illuminates when the machine is drying.

3 Drying time selector dial

Push the dial to pop it out. Graduated up to 120 mins for cottons and synthetics, this dial allows you to select the desired drying time according to the type and quantity of laundry and the required degree of dryness:

- **Blue sector** for cottons
- **Green sector** for synthetics

Turn the dial **clockwise** only.

Cooling phase

To allow the laundry to cool down, a cooling phase starts automatically 10 minutes before the end of drying and this phase must in no circumstances be reduced or interrupted.

4 Heavy soil button

By pressing this button, the machine will take in cold water only on programmes with a water temperature of 50, 60 °C and 95 °C (programmes **B-C-H**). These would normally be hot and cold.

The water is then gradually heated to the required temperature.

The effect is to improve the overall wash performance, particularly on biological stains such as egg, blood and grass stains, and heavily soiled fabrics, since the longer «cool-soak» phase as the water heats up provides the right conditions for the powder and the water temperature to interact, and achieve the best possible results.

5 Spin speed reduction button

By depressing this button the spin speed will be reduced as follows:

- cotton/linen: from 1200 to 650 rpm;
- synthetics/mixed fabrics/delicates: from 650 to 450 rpm
- wool: from 1000 to 650 rpm.

6 Quick wash button

By depressing this button on programmes **B, C, D** and **H** the wash time is reduced.

This is suitable only for garments which are lightly soiled.

7 Rinse Hold Plus button

Press this button to make the machine stop with water in the drum after the cotton, synthetic or delicate wash cycles.

This prevents any creasing which may occur if the clothes are left damp in the drum. When it is convenient for you to empty the machine, simply press this button again so that the machine can proceed to drain and spin, or turn the dial to the drain programme «**S**».

If this button is not activated, the washing programmes will end with a spin.

Do not press this button for woollens: wool items should be gently spun.

Important! The Rinse Hold option is not compatible with the automatic Washing & Drying programme.

8 On/Off button

By depressing this button the machine starts operating.

When depressed again, the machine stops.

The push button is provided with a child-proof safety lock. Move the small slider placed in the middle of the button downwards to lock the button in the «off» position.

9 Mains-on light

This light illuminates when the machine starts working and goes out when the ON/OFF button is released.

10 Programme selector dial

Push the dial to pop it out.

Turn the dial **clockwise** to select the required programme.

Before setting the dial to any position the machine must be switched off by depressing the ON/OFF button again.

Operating Sequence

Before the first wash, we recommend that you run a cotton cycle at 60°C, without any laundry in the machine, to remove any manufacturing residue from the drum and tub.

Pour 1/2 a measure of detergent into the dispenser drawer and start the machine.

Washing 4.5 kg of white cotton at 95°C

Suppose you have 4.5 kg of normally dirty laundry to wash. It is white cotton and is suitable for high temperature washing.

1. Load the laundry

Open the door by pulling the door handle outwards. Place the laundry in the drum, one item at a time, shaking them out as much as possible. Close the door.

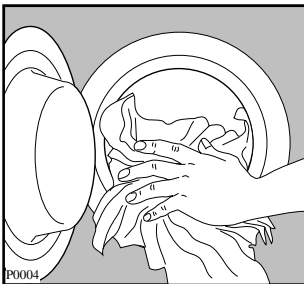

2. Measure out the detergent

Pull out the dispenser drawer until it stops. Measure out the amount of detergent required and pour it into the main wash compartment [1]. If you wish to carry out the prewash, pour detergent into the compartment marked [2].

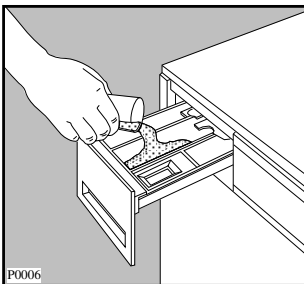

3. Measure out the fabric softener

If required, pour fabric softener into the compartment marked [3] (the amount used must not exceed the "MAX" mark in the drawer).

Close the drawer gently.

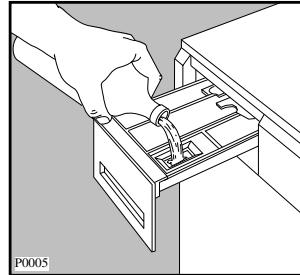

4. Select the required option(s)

Depress HEAVY SOIL and/or SPIN REDUCTION and/or QUICK WASH and/or RINSE HOLD PLUS button, if required.

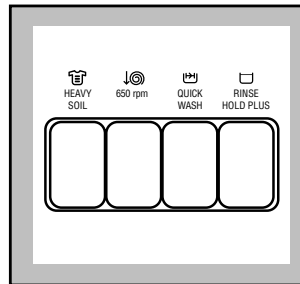

5. Select the required programme

Turn the programme selector dial clockwise to the programme B or A if you wish to perform the prewash before wash.

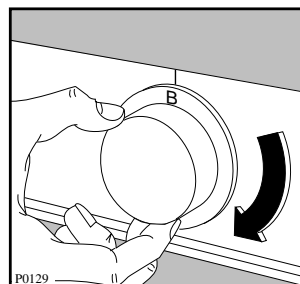

6. Start the machine

Before starting up the machine check that:

- the appliance is plugged in
- the water supply taps are turned on
- the drain hose is correctly and securely positioned
- the door and the detergent dispenser drawer are closed.

Depress the ON/OFF button: the mains-on light and door locked light will illuminate and the machine starts operating.

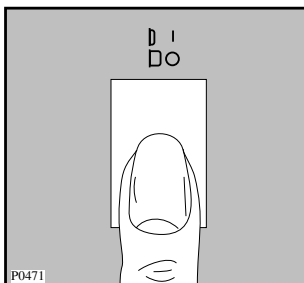

7. At the end of the programme

The machine stops automatically.

If you have depressed the RINSE HOLD PLUS button, the machine will stop with the water left in the tub, to prevent the fabric from creasing. To drain the water and spin, release the same button. To drain only, select programme "S".

The door is controlled by a safety device which releases 2 minutes after the end of the programme. The door can only be opened when the door locked light is off.

Switch the machine off by depressing the ON/OFF button again. The mains-on light goes out.

When the programme has finished you are advised to unplug the appliance and turn off the water taps.

Washing 2 kg of mixed fabrics at 50°C



Suppose you have 2 kg of Mixed fabrics to wash. They are rather delicate fabrics and should not be washed at a high temperature.

1. Load the laundry

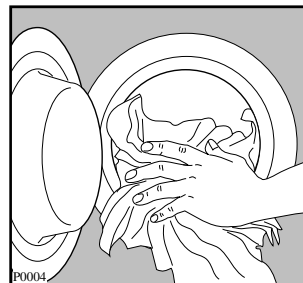
Open the door by pulling the door handle outwards. Place the laundry in the drum, one item at a time, shaking them out as much as possible. Close the door.



2. Measure out the detergent

Pull out the dispenser drawer until it stops. Measure out the amount of detergent required and pour it into the main wash compartment . If you wish to carry out the prewash, pour detergent into the compartment marked .

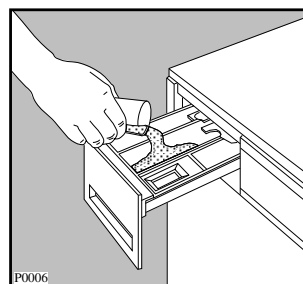

3. Measure out the fabric softener

If required, pour fabric softener into the compartment marked  (the amount used must not exceed the "MAX" mark in the drawer). Close the drawer gently.

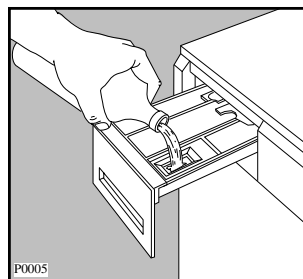

4. Select the required option(s)

Depress HEAVY SOIL and/or SPIN REDUCTION and/or QUICK WASH and/or RINSE HOLD PLUS button, if required.

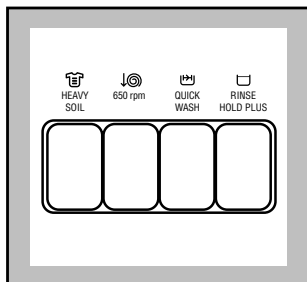

5. Select the required programme

Turn the programme selector dial **clockwise** to the programme H or A if you wish to perform the prewash before wash.

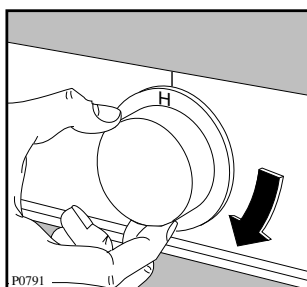

6. Start the machine

Before starting up the machine check that:

- the appliance is plugged in
- the water supply taps are turned on
- the drain hose is correctly and securely positioned
- the door and the detergent dispenser drawer are closed.

Depress the ON/OFF button: the mains-on light and door locked light will illuminate and the machine starts operating.

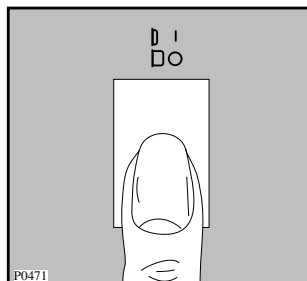

7. At the end of the programme

The machine stops automatically.

If you have depressed the RINSE HOLD PLUS button, the machine will stop with the water left in the tub, to prevent the fabric from creasing. To drain the water and spin, release the same button. To drain only, select programme "S".

The door is controlled by a safety device which releases 2 minutes after the end of the programme.

The door can only be opened when the door locked light is off.

Switch the machine off by depressing the ON/OFF button again. The mains-on light goes out.

When the programme has finished you are advised to unplug the appliance and turn off the water taps.

Drying 2.25 kg of cotton

You have for example just machine-washed and spun at 1200 rpm 4.5 kg (10 lb) of laundry.

They are cotton fabrics of medium weight which do not need ironing.

Switch off the machine.

Then remove the laundry from the appliance and divide the items to obtain two loads of approx. 2.25 kg (5 lb) each.

1. Load the laundry

Open the door by pulling the door handle outwards.

Load the items one at a time and close the door.

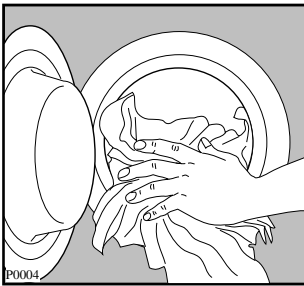

2. Select the programme

Turn the programme selector dial clockwise to programme **G**.

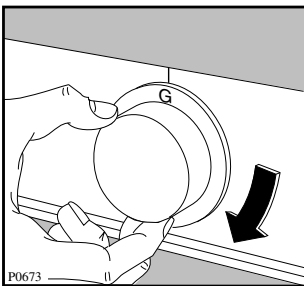

3. Select the required time

Following indications given in the programme chart on page 18, turn the time selector dial clockwise to the 90 mins setting in the blue sector.

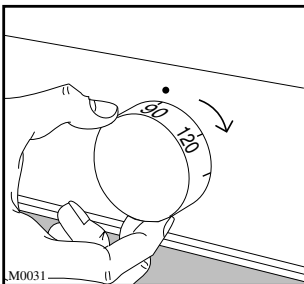

4. Start the machine

Depress the ON/OFF button, the mains-on light, door locked light and drying light will illuminate and the machine starts operating.

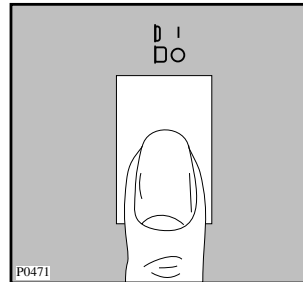

5. At the end of the programme

The machine stops automatically and the drying light goes out.

The door is controlled by a safety device which releases 2 minutes after the end of the programme.

The door can be opened after the door locked light has gone out.

Switch the machine off by depressing the ON/OFF button again, the mains-on light goes out.

If the laundry is still too damp, select a further brief drying time, bearing in mind that during the last 10 minutes the appliance carries out a cooling and anticrease phase.

When the programme has finished you are advised to unplug the appliance and turn off the water taps.

Autodrying 1 kg of mixed fabrics



You intend to wash and dry automatically 1 kg (2.2 lb) of mixed fabrics which you want to iron as soon as they are dry.

Proceed as follows:

1. Load the laundry

Open the door by pulling the door handle outwards. Load the items one at a time and close the door.

2. Measure out the detergent and fabric softener

Pull out the dispenser drawer until it stops. Measure out the amount of detergent required and pour it into the main wash compartment . If required, pour fabric softener into the compartment marked  (the amount used must not exceed the "MAX" mark in the drawer). Close the drawer gently.

3. Select the programme

Turn the programme selector dial **clockwise** to programme **H**.

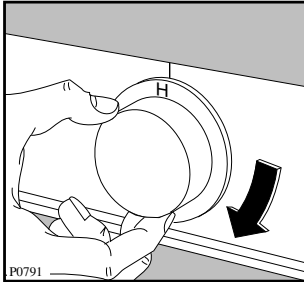

4. Select the required option

Depress QUICK WASH and/or HEAVY SOIL button, if required.

5. Select the required time

Following indications given in the programme chart on page 18, turn the time selector dial **clockwise** to the 50 mins setting in the green sector.

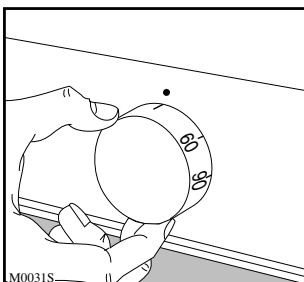

6. Start the machine

Depress the ON/OFF button: the mains-on light and door locked light come on and the machine starts operating.

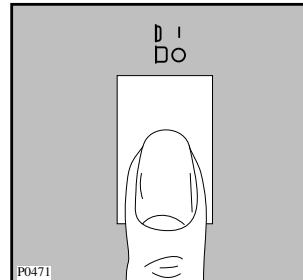

7. At the end of the programme

The machine stops automatically and the drying light goes out.

The door is controlled by a safety device which releases 2 minutes after the end of the programme. The door can be opened after the door locked light has gone out.

Switch the machine off by depressing the ON/OFF button again, the mains-on light goes out.

If the laundry is still too damp, select a further brief drying time, bearing in mind that during the last 10 minutes the appliance carries out a cooling and anticrease phase.

When the programme has finished you are advised to unplug the appliance and turn off the water taps.

Washing Hints

Do **NOT** overload the machine. Weigh the laundry the first few times you use the appliance.

The average weights of the most common items are listed below as a guide:

1000 g = 1 kg

Sheet	700-1000 g
Pillow case	100-200 g
Tablecloth	400-500 g
Serviette	50-100 g
Tea towel	70-120 g
Linen hand towel	100-150 g
Towelling hand towel	150-250 g
Towelling bath towel	700-1000 g
Bath robe	1000-1500 g
Man's shirt	200-300 g
Apron	150-200 g

- Load the laundry loosely alternating large items with small ones.
- Sort the laundry according to the type of fabric, colour-fastness and how dirty it is.
- Avoid washing unhemmed or torn items as they may unravel.
- Before washing, empty all pockets of small objects which may have been left inside (coins, keys, screws etc), as these could damage the drain pump.
- When washing curtains, remove the hooks.
- Close poppers and zips and fasten loose buttons.
- It is essential to wash new coloured items separately when washing for the first time.
- When washing fabrics requiring different wash temperatures together, always select the lowest temperature.
- White items should not be washed with coloured items.
- Very small items (handkerchiefs, ribbons, socks etc) should be washed in a washing bag or a pillow case.
- Use a good quality detergent suitable for automatic washing machines.
- Use the correct quantities of detergent.
- For wool, use gentle detergent only in small quantities.

- Bleach is very corrosive; it should be used with care and kept out of reach of children.
- Some stains such as fruit, wine, grass, rust etc. are difficult to remove and should be treated before washing with specific products, which can be found in most household shops. In some cases it may help to soak the stain before washing with a special pre-soak product or biological detergent.
- Only wool marked "Pure New Wool - washable, preshrunk" can be washed in the machine using the wool programme; other types of wool should be washed by hand or dry cleaned.
- If you have used the machine to wash, rinse or spin only non-colour fast garments, there may be dye left in the sump. To ensure any subsequent wash is not contaminated with the dye, select and carry out a rinse and spin programme, without any garments, to ensure that any dye is removed from the sump.
- Once you have finished using the machine, you are advised to unplug it and turn off the water taps.

«JETSYSYSTEM» wash

As the Jetsystem is flexible and adjusts water intake according to wash load size it is not possible to give you exact recommendations as to the amount of detergent that should be used for any one wash. Therefore we recommend that you use approximately 1/3 less than the detergent manufacturer recommends on the packet or bottle, making the appropriate allowances for soft or hard water, and light or heavy soilage of clothes. If you have judged the amount correctly you should expect to see a soft sudsy liquid during the wash. It is not necessary to have a head of lather on the water.

Which detergent?....

To ensure you obtain the best wash results from your appliance, it is important to use the right detergent in your everyday wash, and only detergents recommended for use in automatic machines.

To maintain the appearance of your clothes and household textiles and to make them last longer you should use different types of detergent for different washes, whether for whites, colours or delicates.

Whites

We recommend the Ariel product range which is biological and designed to provide excellent cleaning and stain removal even at low temperatures.



Non Biological

If you prefer to use a non biological detergent, which does not contain enzymes we recommend Fairy. Fairy provides good cleaning and stain removal.



Coloureds

For coloured items you should use a detergent which is designed to clean while maintaining the original colour. Ariel Color does not contain bleach and therefore helps to preserve colours.



Delicate Items

When washing delicates such as woollens, you should use a product which is specially designed to care for fine fabrics.

Dreft Automatic is suitable for woollens and other delicates.

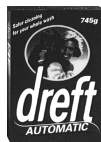

Laundry Bleach

For additional stain removal you may wish to use a product such as Ace Gentle Bleach which is used in addition to your chosen detergent. Ace is suitable for all washable fabrics including silks, woollens and coloureds.



And in which form?

Not only are there different types of detergent, but they are also available in different forms. Whether you chose a powder or liquid in traditional or compact form is your own personal choice.

Traditional Powders

Pour the powder directly into the dispenser drawer. Do not sprinkle powder onto clothes in the machine drum.

Traditional Liquids

Liquid can be placed in the main wash compartment of the detergent drawer marked with the symbol , start the machine immediately upon placing the detergent in the dispenser drawer.

Alternatively the detergent is measured into the specially designed dosing device* which should be placed on top of the laundry, and at the back of the machine drum.

Compact Powders and Liquids

Compact detergents (or concentrates as they are also known) are available in liquid or powder form, and generally require a smaller dosage. Follow the manufacturer's instructions to ensure the most economical usage. Pour the detergent directly into the dispenser drawer, or alternatively measure the detergent into the specially designed dosing device* which should be placed on top of the laundry, and at the back of the machine drum.

* If you use a dosing device in a washer-dryer, please ensure the dosing device/ball is removed before carrying out a drying programme.

Fabric Conditioners

These are ideal for improving "softness", and also reduce static cling on synthetics and make ironing easier. They are available in two types:

For example Lenor liquid fabric softener, for use in the **washing machine/washer dryer**. The liquid fabric softener should be poured into the compartment marked with the symbol .

Follow the manufacturer's dosage instructions and never exceed the MAX level.



Bounce conditioning sheets for use in a **tumble dryer**. We recommend the conditioning sheets are pinned (using a safety pin) to an article of laundry and placed in the tumble dryer.



Drying hints

As a dryer, the machine works on the condensation principle.

Therefore, **the water taps must be open and the drain hose must drain water into a sink or into the drain pipe, even during the drying cycle.**

Load

Sort of laundry	max. load (dry weight)
Linen and cottons	2.25 kg
Synthetics	1.5 kg

Warning:

Loads of washed laundry exceeding these values must be divided before being dried, otherwise poor results will be obtained.

Garments not suitable for drying

- Particularly delicate items such as synthetic curtains, woollen and silk, garments with metal inserts, nylon stockings, bulky garments such as anoraks, bedcovers, quilts, sleeping bags and duvets must not be machine dried.
- Garments padded with foam-rubber or materials similar to foam-rubber must not be machine dried; they represent a fire hazard.
- Also, fabrics containing residues of setting lotions or hair sprays, nail solvents or similar solutions must not be machine dried in order to avoid the formation of harmful vapours.

Drying symbols on garment labels

Always look at the garment label to check whether garments can be machine dried.

The following symbols refer to drying:



Machine drying is usually possible



Normal drying (normal temperature)



Gentle drying (reduced temperature)



Do not machine dry

Duration of the drying cycle

The drying time can vary according to

- the final spin speed,
- the required degree of drying,
- the type of laundry
- the size of load.

The usual drying times are indicated in the programme chart. As you become more familiar with the appliance, you will discover the drying times that best suit your needs according to the various type of fabric. It is a good idea to make a note of these times.

The following are the degrees of final drying which can be selected for cotton and synthetics:

- Store dry
- Iron dry

When selecting the drying time you should remember that it includes a 10 minute cooling phase.

Additional drying

Should the laundry still be too wet at the end of the programme, set another short drying time.

Warning! To prevent the formation of creases or shrinking of fabrics, avoid excessive drying.

















Fibre residue

After drying fluffy fabrics, such as new towels, it is advisable to perform the rinse programme **P** to be sure that any residue that may remain in the tub is completely removed and does not stick to garments dried afterwards.

After each drying cycle the filter should be checked and cleaned if necessary.

Wash Care Symbols

Wash care labels inside garments recommend how to launder your clothes with the best results. The care labelling code is in line with care labelling used in the rest of Europe. The symbols used make it easy to select the correct programme on your washing machine.

WASHING SYMBOL	WASH ACTION	FABRIC
	Normal (Maximum)	White Cotton or Linen without Special Finishes
	Normal (Maximum)	Cotton, Linen or Viscose without Special Finishes Colourfast at 60°C.
	Reduced (Medium)	Nylon, Polyester/Cotton, Viscose with Special Finishes, Cotton/Acrylic Mix.
	Normal (Maximum)	Cotton, Linen or Viscose Colourfast at 40°C but not 60°C.
	Reduced (Medium)	Acrylics, Acetate, Triacetate, Wool mixes, Polyester/wool blends.
	Much Reduced (Minimum)	Wool, wool mixtures, Silks
	Hand wash only	Do not machine wash
BLEACHING		
	Chlorine bleach may be used	
IRONING		
	Hot iron	Cotton, Linen, Viscose
	Warm iron	Polyester mixtures, Wool
	Cool iron	Acrylic, Nylon, Polyester
DRY CLEANING		
	May be dry cleaned. Other letters and/or a bar beneath the circle will indicate the required process to the dry cleaner.	
TUMBLE DRYING		
	with high heat setting	
	with low heat setting	
	May be tumble dried	
	A cross through any symbol means «DO NOT»	









Important Notes

For best results, always use the dispenser drawer for dispensing detergents and liquid additives. Once the dispenser has been filled, close it by pushing it in gently. This is particularly important if you are using fabric conditioner to avoid the conditioner entering the

machine prematurely. When using liquid detergent and a prewash programme, place the detergent into the correct compartment in the dispenser drawer, **after** the prewash has finished.

Washing Programmes

Programmes for cotton and linen

Wash programme	Degree of soil and type of laundry	Programme dial position	Description	Possible options	Max. load	Progr. time mins.
 PREWASH	For heavy soiled cotton items (whites and coloureds).	A	Prewash at 40 °C Short spin at 650 rpm		4.5 kg	18
 BOILWASH	White cotton, for example normally soiled work garments, sheets, household linen, underwear, towels.	B	Wash at 95 °C 3 rinses Long spin		4.5 kg	105
 FAST COLOURED	Fast coloured cotton or linen fabrics, shirts, underwear, towels.	C(*)	Wash at 60 °C 3 rinses Long spin		4.5 kg	105
 NON- FAST COLOURED	Non fast coloured cotton or linen fabrics, shirts, blouses, underwear.	D	Wash at 40 °C 3 rinses Long spin		4.5 kg	88
SPIN 1200 rpm	Separate spin for cotton and linen items	F	Long spin		4.5 kg	10















(*) This programme at 60°C is the reference programme for the Energy label according to EEC Directive 92/75.

Water filling: 30°-40° programmes: **cold** water filling
50°-60°-95° programmes: **hot** and **cold** filling

The programme times are intended as a guide only. The actual time will vary depending on incoming water temperature and pressure.

Washing Programmes

Programmes for synthetics, delicates and wool

Wash programme	Degree of soil and type of laundry	Programme dial position	Description	Possible options	Max. load	Progr. time mins.
 PREWASH	Heavy soiled synthetics or mixed fabrics, not wool	A	Prewash at 40 °C Short spin at 650 rpm		2 kg	15
 MIXED FABRICS	Synthetic or mixed fabrics, underwear, coloured garments, non-shrink shirts, blouses.	H	Wash at 50 °C 3 rinses Short spin		2 kg	70
 MIXED FABRICS	Underwear, no-iron shirts, blouses	J	Wash at 40 °C 3 rinses Short spin		2 kg	40
30° WORN ONCE	Lightly soiled synthetic or delicate items	K	Wash at 30 °C 3 rinses Short spin		2 kg	40
 WOOL 	Specially tested programme for wool garments bearing the "Pure new wool, non-shrink, machine washable" label.	M	Wash at 40 °C 3 rinses Short spin		1 kg	60
 DELICATES	Delicate fabrics, for example curtains	N	Wash at 40 °C 3 rinses Short spin		2 kg	48
HAND RINSES	Separate rinse cycle for hand washed garments	P	3 rinses Short spin		2 kg	23
FRESHEN UP	This programme can be used for softening hand washed garments.	Q	1 rinse, with fabric softener, if required Short spin		2 kg	10
SHORT SPIN	Separate spin for synthetics and delicates	R	Draining of water and short spin		2 kg	5
DRAIN	For emptying out the last rinse water in programmes with the Rinse Hold Plus option.	S	Draining of water		-	1

Drying Programmes

Programme	Degree of drying	Type of fabric	Max. load	Spin speed	Drying time mins.
G Cotton & linen	Store dry (*) for items which you want to put away without ironing	Bathrobes, bath towels, terry towels, knitwear, babywear	2.25 kg	1200 rpm	90
			1 kg	1200 rpm	50
L Mixed fabrics, synthetics		Shirts, blouses, outerwear	1.5 kg	650 rpm 900 rpm (**)	120 90
			1 kg	650 rpm 900 rpm (**)	80 60
G Cotton & linen	Iron dry for items which need ironing	Sheets, tablecloths, table napkins etc.	2.25 kg	1200 rpm	70
			1 kg	1200 rpm	40
L Mixed fabrics, synthetics		Household linen, shirts, blouses	1.5 kg	650 rpm 900 rpm (**)	100 70
			1 kg	650 rpm 900 rpm (**)	60 50

(*) This programme for cotton items is the reference programme for the Energy label according to the EEC Directive 92/75.

(**) If you perform the automatic Washing & Drying Programme for mixed fabrics/synthetics the final spin will be 900 rpm instead of 650 rpm.

Maintenance and Cleaning

Before any maintenance or cleaning is carried out you must **DISCONNECT** the appliance from the electricity supply.

Descaling

The water we use normally contains lime. It is a good idea to periodically use a water softening powder in the machine. Do this separately from any laundry washing, and according to the softening powder manufacturer's instructions. This will help to prevent the formation of lime deposits.

After each wash

Leave the door open for a while. This helps to prevent mould and stagnant smells forming inside the appliance. Keeping the door open after a wash will also help to preserve the door seal.

External cleaning

Clean the exterior cabinet of the appliance with soap and water only, and then dry thoroughly.

Cleaning the dispenser drawer

From time to time the washing powder and additive dispenser drawer should be cleaned. Remove the drawer by pressing the catch downwards and by pulling it out. Flush it out under a tap, to remove any traces of accumulated powder.

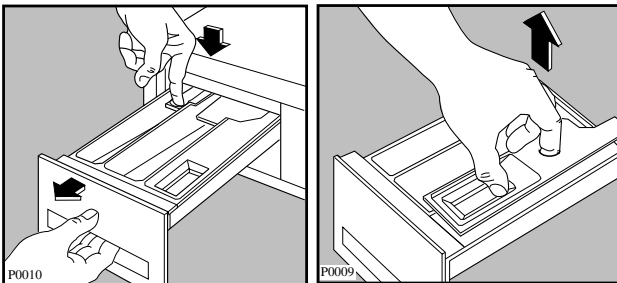

Cleaning the drawer recess

Having removed the drawer, use a small brush to clean the recess, ensuring that all washing powder residue is removed from the upper and lower part of the recess. Replace the drawer and run the rinse programme without any clothes in the drum.

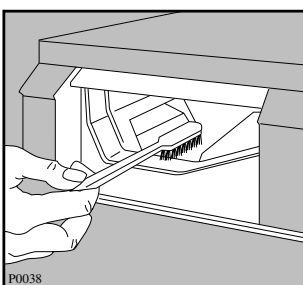

Cleaning the filter

The water drain filter

A clean filter is important for the correct functioning of the machine, and should therefore be cleaned after every washing and drying programme.

Place a container under the filter to catch any spillage. If the filter is blocked and the machine is unable to drain you will need to drain the water manually from the machine at this stage. To do this, unhook the drain hose from the standpipe or sink and hold the end of the hose over a bowl on the floor. The water should drain by gravity into the bowl. When the bowl is full, hook the hose back up and empty the bowl. Repeat the procedure until water stops flowing out. Unscrew and remove the filter.

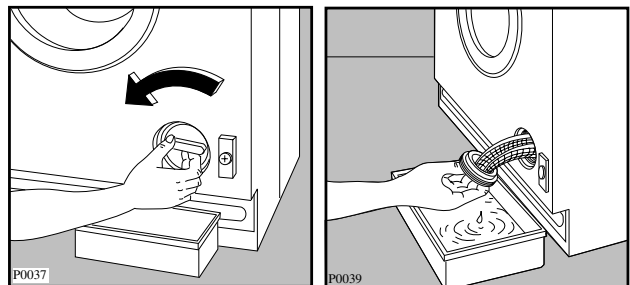

Clean carefully under a fast running tap.

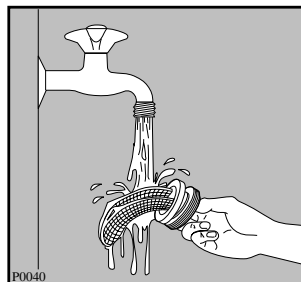

Warning

When the appliance is in use and depending on the programme selected there can be hot water in the filter. Never remove the filter during a wash cycle, always wait until the appliance has finished the cycle, and is empty. When replacing the filter, ensure it is securely retightened so as to stop leaks and young children being able to remove it.

The water inlet filters

If your water is very hard or contains traces of lime deposit, the water inlet filters may become clogged.

It is therefore a good idea to clean them from time to time.

Turn off the water taps. Unscrew the water inlet hoses.

Clean the filters using a hard bristle brush.

Tighten up the inlet hoses.

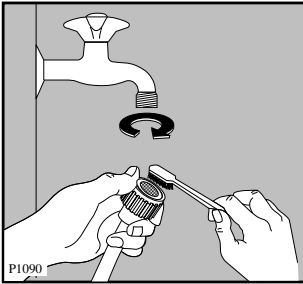

The dangers of freezing

If the machine is exposed to temperatures below 0°C, certain precautions should be taken.

- Turn off the water taps.
- Unscrew the inlet hoses.
- Unhook the drain hose from the rear support and position the end of this hose and that of the inlet hoses in a bowl. Run the draining programme.
- Disconnect the appliance.
- Screw the inlet hoses and reposition the drain hose.
- When you intend to start the machine up again, make sure that the room temperature is above 0°C.

Maintenance Wash

With the use of low temperature washes it is possible to get a build up of residues inside the drum.

We recommend that a maintenance wash be performed on a regular basis.

To run a maintenance wash:

- The drum should be empty of laundry.
- Select the hottest cotton wash programme.
- Use a normal measure of detergent, must be a powder (such as Ariel Futur).

Something Not Working

Certain problems are due to lack of simple maintenance or oversights, which can be solved easily without calling out an engineer. Before contacting your local Service Force Centre, please carry out the checks listed below.

IMPORTANT: if you call out an engineer to a fault listed below, or to repair a fault caused by incorrect use or installation, a charge will be made even if the appliance is under guarantee.

Symptom	Possible causes
The machine does not start	<ul style="list-style-type: none"> • The door has not been closed. • The plug is not properly inserted in the power socket. • There is no current at the socket • The main fuse or the fuse in the plug has blown. • The selector dial is not correctly positioned. • The ON/OFF button has not been depressed.
The machine does not fill	<ul style="list-style-type: none"> • Ensure the water taps are open. • The filters in the inlet hoses are blocked. • The inlet hoses may be squashed or kinked. • The door has not been closed.
The machine fills then empties immediately	<ul style="list-style-type: none"> • The end of the drain hose is too low. • The end of the drain hose is submerged in water. • There is no vent in the end of the drain hose.
The machine does not empty and/or does not spin	<ul style="list-style-type: none"> • The drain hose may be squashed or kinked. • The RINSE HOLD option has been selected. • The drain filter may be blocked. • The drain hose extension is not correct. Follow the instructions for connecting to the waste. • The drainage system pipes are blocked. • The wash load is unbalanced: redistribute the clothes inside the drum to allow the machine to spin.
There is water on the floor	<ul style="list-style-type: none"> • Too much detergent or unsuitable detergent has been used (creates too much foam). • Check whether there are any leaks from one of the inlet hose(s) fittings. It is not always easy to see this as the water runs down the hose; check to see if it is damp. • The drain hose may be damaged or not securely positioned. • The detergent dispenser drawer or recess is clogged. • The drainage system pipes are blocked.
Unsatisfactory washing results	<ul style="list-style-type: none"> • Too little detergent or unsuitable detergent has been used. An insufficient amount of detergent leaves the laundry looking grey and causes lime scale to form. • Stubborn stains have not been treated prior to washing • The correct wash programme has not been selected. • Too much laundry has been placed in the drum.
The machine vibrates when spinning	<ul style="list-style-type: none"> • The internal packing has not been removed. • The machine is in contact with the wall or furniture. • The machine is not level. • The washing load is badly distributed in the drum. • Maybe there is very little laundry in the drum.

Symptom	Possible causes
The door will not open	<ul style="list-style-type: none"> • The programme is still running. • The door lock has not yet released (door pilot light on). • There is water in the tub
Spinning starts late or the machine does not spin	<ul style="list-style-type: none"> • The electronic unbalance detection device has cut in because the laundry is not evenly distributed in the drum. The laundry is redistributed by reverse rotation of the drum. This may happen several times before the unbalance disappears and normal spinning can resume. If, after 10 minutes, the laundry is still not evenly distributed in the drum, the machine will not spin. In this case, redistribute the load manually and reselect the spin programme.
The machine makes an unusual noise	<ul style="list-style-type: none"> • The machine is fitted with a type of motor which makes an unusual noise compared with other traditional motors. This new motor ensures a softer start and more even distribution of the laundry in the drum when spinning, as well as increased stability of the machine.
No water is visible in the drum	<ul style="list-style-type: none"> • Machines based on modern technology operate very economically using very little water without affecting performance.
The machine does not dry or does not dry properly	<ul style="list-style-type: none"> • The drying time has not been selected • The water taps are not turned on • The drain filter is clogged • The machine is overloaded • The selected drying time or sector are not suitable for the laundry

Service & Spare Parts

In the event of your appliance requiring service, or if you wish to purchase spare parts, please contact your local Zanussi Service Force Centre by telephoning:

0870 5 929929

Your telephone call will be automatically routed to the Service Force Centre covering your post code area. The addresses are listed on the following pages. Before calling out an engineer, please ensure you have read the details under the heading "Something Not Working".

When you contact the Service Force Centre you will need to give the following details:

1. Your name, address and post code
2. Your telephone number
3. Clear and concise details of fault
4. The model and serial number of the appliance (found on the rating plate - see picture).
5. The purchase date

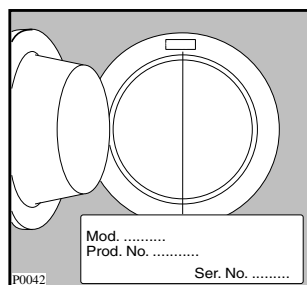

Customer Care

For general enquiries concerning your Zanussi appliance or for further information on Zanussi products, please contact our Customer Care Department by letter or telephone as follows:

Customer Care Department

Zanussi

55-77 High Street

Slough

Berkshire

SL1 1DZ

Tel 08705 727727*

or visit our website at www.zanussi.co.uk

* calls to this number may be recorded for training purposes.

Zanussi Guarantee Conditions

Standard guarantee conditions

We, Zanussi undertake that if, within 24 months of the date of the purchase, this Zanussi appliance or any part thereof is proved to be defective by reason only of faulty workmanship or materials, we will, at our option, repair or replace the same **FREE OF ANY CHARGE** for labour, materials or carriage on condition that:

- The appliance has been correctly installed and used only on the electricity supply stated on the rating plate.
- The appliance has been used for normal domestic purposes only, and in accordance with the manufacturer's instructions.
- The appliance has not been serviced, maintained, repaired, taken apart or tampered with, by any person not authorised by us.

All service work under this guarantee must be undertaken by a Zanussi Service Force Centre.

Any appliance or defective part replaced shall become the Company's property.

This guarantee is in addition to your statutory and other legal rights.

Home visits are made between **8.30am** and **5.30pm** Monday to Friday. Visits may be available outside these hours in which case a **premium** will be charged.

Exclusions

This guarantee does not cover:

- Damage or calls resulting from transportation, improper use or neglect, the replacement of any light bulbs or removable parts of glass or plastic.
- Costs incurred for calls to put right an appliance which is improperly installed or calls to appliances outside the United Kingdom.
- Appliances found to be in use within a commercial environment, plus those which are subject to rental agreements.
- Products of Zanussi manufacture which are NOT marketed by Zanussi.
- **This guarantee does not cover freestanding appliances which have a 12 months guarantee.**

European guarantee

If you should move to another country within Europe then your guarantee moves with you to your new home subject to the following qualifications:

- The guarantee starts from the date you first purchased your product.
- The guarantee is for the same period and to the same extent for labour and parts as exists in the new country of use for this brand or range of products.
- The guarantee relates to you and cannot be transferred to another user.
- Your new home is within the European Community (EC) or European Free Trade Area.
- The product is installed and used in accordance with our instructions and is only used domestically, i.e. a normal household.
- The product is installed taking into account regulations in your new country.

Before you move please contact your nearest Customer Care Centre, listed below, to give them details of your new home. They will then ensure that the local Service Organisation is aware of your move and able to look after you and your appliances.

France	Senlis	+33 (0)344 62 29 99
Germany	Numberg	+49 (0)911 323 2600
Italy	Pordenone	+39 (0)1678 47053
Sweden	Stockholm	+46 (0)8 738 79 50
UK	Slough	+44 (0)1753 219897





To contact your local Zanussi Service Force Centre telephone **08705 929 929**

CHANNEL ISLANDS		ORKNEY (M65) Corsie Domestics 7 King Street Kirkwall Orkney KW15	NORTH EAST	
GUERNSEY	Guernsey Electricity PO Box 4 Vale, Guernsey Channel Islands	PERTH Hydro Electrical Inveralmond House Ruthervanfield Road Perth PH1 3AQ	GATESHEAD (M39)	Unit 356a Dukesway Court Dukesway Team Valley Gateshead NE11 0BH
JERSEY	Jersey Electricity Company PO Box 45 Queens Road St Helier Jersey Channel Islands JE4 8NY	PERTH (OWN SALES) Graham Begg Unit 4 Airport Ind Estate Wick KW1 4QS	GRIMSBY (M42)	15 Hainton Avenue Grimsby South Humberstone DN32 9AS
SCOTLAND		SHETLAND (OWN SALES) Tait Electronic Systems Ltd Holmsgarth Road Lerwick Shetland ZE1 0PW	HULL (M41)	Unit 1 Boulevard Industrial Estate Hull HU3 4AY
ABERDEEN (M05)	54 Claremont Street Aberdeen AB10 6RA	SHETLAND (OWN SALES) Bolts Shetland Ltd. 26 North Road Lerwick Shetland ZE1 0PE	LEEDS (M37)	64-66 Cross Gates Road Leeds LS15 7NN
AUCHTERMUCHY (M03)	33a Burnside Auchtermuchy Fife KY14 7AJ	WHALSAY (OWN SALES) Leask Electrical Harisdale Symbister, Whalsay Shetland ZE2 9AA	NEWTON AYCLIFFE (M45)	Unit 16 Gurney Way Aycliffe Industrial Estate Newton Aycliffe DL5 6UJ
BLANTYRE (M07)	Unit 5 Block 2 Auchenraith Ind. Estate Rosendale Way Blantyre G72 0NJ	NORTHERN IRELAND		
DUMFRIES (M01)	93 Irish Street Dumfries Scotland DG1 2PQ	BELFAST (M27)	Owenmore House Kilwee Business Park Upper Dunmury Lane Belfast BT17 0HD	
DUNOON (M67)	Brair Hill 7 Hill Street Dunoon Argyll PA23 7AL	WALES		
GLASGOW (M04)	20 Cunningham Road Clyde Estate Rutherglen Glasgow G73 1PP	CARDIFF (M28)	Guardian Industrial Estate Clydesmuir Road Tremorfa Cardiff CF2 2QS	
INVERNESS (M06)	Unit 3B Smithton Ind. Estate Smithton Inverness IV1 AJ	CLYWD (M14)	Unit 6-7 Coed – Parc Abergele Road Rhuddlan Clwyd Wales LL18 5UG	
ISLE OF ARRAN (OWN SALES)	Arran Domestics Unit 4 The Douglas Centre Brodrick Isle of Arran KA27 8AJ	DYFED (M77)	Maes Y Coed High Mead Llanybydder Carmarthenshire SA40 9UL	
ISLE OF BARRA (OWN SALES)	J Zerfah 244 Bruernish Isle of Barra Western Islands HS9 5QY	HAVERFORDWEST (M75)	Cromlech Lodge Ambleton Haverfordwest Pembrokeshire SA62 5DS	
ISLES OF BUTE	Walker Engineering Glenmhor Upper Serpentine Road Rothesay Isle of Bute PA20 9EH	OSWESTRY (M17)	Plas Ffynnon Warehouse Middleton Road Oswestry SY11 2PP	
ISLE OF LEWIS	ND Macleod 16 James Street Stornoway Isle of Lewis PA87 2QW	NORTH WEST		
KELSO (M08)	2-8 Wood Market Kelso Borders TD5 7AX	BIRKENHEAD (M11)	1 Kelvin Park Dock Road Birkenhead L41 1LT	
		CARLISLE (M10)	Unit 7 James Street Workshops James Street Carlisle Cumbria CA2 5AH	
		ISLE OF MAN (M64)	South Quay Ind. Estate Douglas Isle of Man IM1 5AT	
		LIVERPOOL (M15)	Unit 1 Honeys Green Precinct Honeys Green Lane Liverpool L12 9JH	
		MANCHESTER (M09)	Unit B Central Industrial Estate St Marks Street Bolton BL3 6NR	
		PRESTON (M13)	Unit 250 Dawson Place Walton Summit Bamber Bridge Preston Lancashire PR5 8AL	
		STOCKPORT (M16)	Unit 20 Haigh Park Haigh Avenue Stockport SK4 1QR	

To contact your local Zanussi Service Force Centre telephone **08705 929 929**

MIDLANDS		LONDON & EAST ANGLIA		SUNBURY (M63)	Unit 1a The Summit Hanworth Road Hanworth Ind. Estate Sunbury on Thames TW16 5D
BIRMINGHAM (M18)	66 Birch Road East Wyrley Road Ind. Estate Witton Birmingham B6 6DB	BECKENHAM (M79)	11a Gardener Ind. Estate Kent House Lane Beckenham Kent BR3 1QZ	SOUTH EAST	
BOURNE (M44)	Manning Road Ind. Estate Pinfold Road Bourne PE10 9HT	CHELMSFORD (M47)	Hanbury Road Widford Ind. Estate Chelmsford Essex CM12 3AE	ASHFORD (M58)	Unit 2 Bridge Road Business Est. Bridge Road Ashford Kent TN2 1BB
BRIDGNORTH (M72)	68 St. Mary's Street Bridgnorth Shropshire WV16 4DR	COLINDALE (M53)	Unit 14 Capitol Park Capitol Way Colindale London NW9 0EQ	FLEET (M59)	Unit 1 Redsfield Ind. Estate Church Crookham Fleet Hampshire GU13 0RD
GLOUCESTER (M23)	101 Rycroft Street Gloucester GL1 4NB	ELTHAM (M78)	194 Court Road Mottingham Eltham London SE9 4EW	HAYWARDS HEATH (M55)	21-25 Bridge Road Haywards Heath Sussex RH16 1UA
HEREFORD (M31)	Unit 3 Bank Buildings Cattle market Hereford HE4 9HX	ENFIELD (M49)	284 Alma Road Enfield London EN3 7BB	SOUTH WEST	
HIGHAM FERRERS (M51)	30 High Street Higham Ferrers Northants NN10 8BB	GRAVESEND (M57)	Unit B4 Imperial Business Estate Gravesend Kent DA11 0DL	BARNSTAPLE (M30)	Main Road Fremington Barnstaple North Devon EX31 2NT
ILKESTON (M43)	Unit 2 Furnace Road Ilkeston DE7 5EP	HARPENDEN (M46)	Unit 4 Riverside Estate Coldharbour Lane Harpenden AL5 4UN	BOURNEMOUTH (M26)	63-65 Curzon Road Bournemouth Dorset BH1 4PW
LEICESTER (M22)	Unit 7 Oaks Ind. Estate Coventry Road Narborough Leicestershire LE0 5GF	LETCHWORTH (M50)	16-17 Woodside Ind. Estate Works Road Letchworth Herts SG6 1LA	BRIDGEWATER (M35)	6 Hamp Ind. Estate Bridgewater Somerset TA6 3NT
LINCOLN (M40)	Unit 8 Stonefield Park Clifton Street Lincoln LN5 8AA	LONDON (M76)	2/4 Royal Lane Yiewsley West Drayton Middlesex UB7 8DL	BRISTOL (M25)	11 Eldon Way Eldonwall Trading Bristol Avon BS4 3QQ
NEWCASTLE UNDER LYME (M12)	18-21 Croft Road Brampton Ind. Estate Newcastle under Lyme Staffordshire ST5 0TW	MAIDENHEAD (M60)	Reform Road Maidenhead Berkshire SL6 8BY	EMSWORTH (M33)	266 Main Road Southbourne Emsworth PO10 8JL
REDDITCH (M20)	13 Thornhill Road North Moons Moat Redditch Worcestershire B98 9ND	MOLESEY (M61)	10 Island Farm Avenue West Molesey Surrey KT8 2UZ	ISLE OF WIGHT (M34)	Unit 8 Enterprise Court Ryde Business Park Ryde Isle of Wight PO33 1DB
TAMWORTH (M19)	Unit 3 Sterling Park Claymore Tamworth B77 5DO	NEWBURY (M24)	9 Pipers Court Berkshire Drive Thatcham Berkshire RG19 4ER	NEWTON ABBOT (M29)	Unit 2 Zealley Ind. Estate Kingsteignton Newton Abbot S. Devon TQ12 3TD
WORCESTER (M73)	Units 1 & 2 Northbrook Close Gregorys Mill Ind. Estate Worcester WR3 8BP	IPSWICH (M48)	Unit 6C Elton Park Business Centre Hadleigh Road Ipswich IP2 0DD	REDRUTH (M36)	Unit 7D Pool Ind. Estate Wilson Way Redruth Cornwall TR15 3QW
		NORWICH (M52)	2b Trafalgar Street Norwich NR1 3HN		

Installation Instructions

-  It is dangerous to alter the specifications or attempt to modify this product in any way.
-  Care must be taken to ensure that the appliance does not stand on the electrical supply cable.
-  Any electrical work required to install this appliance should be carried out by a qualified electrician or competent person.
-  Any plumbing work required to install this appliance should be carried out by a qualified plumber or competent person.

Technical Specifications

DIMENSIONS	Height Width Depth	82 cm (32.3") 60 cm (23.6") 54 cm (21.2")
POWER SUPPLY VOLTAGE TOTAL POWER ABSORBED		230-240 V/50 Hz 2550 W (13A)
WATER PRESSURE	Minimum (hot) Minimum Maximum	0.35 bar (3.5 N/cm ²) 0.48 bar (4.8 N/cm ²) 7.6 bar (76 N/cm ²)
MAXIMUM RECOMMENDED LOAD	Washing Cotton, linen Synthetics Delicate fabrics Wool Drying Cotton, linen Synthetics	4.5 kg (10 lbs) 2 kg (4.5 lbs) 2 kg (4.5 lbs) 1 kg (2.2 lbs) 2.25 kg (5 lbs) 1.5 kg (3.3 lbs)
SPIN SPEED	Maximum	1200 rpm
CONSUMPTION DATA FOR WASHING 4.5 KG NORMALLY SOILED COTTON ITEMS AT 60°C (PROGR. C) WITH COLD WATER FILLING	Energy Water Time	1.10 kWh 53 litres 125 mins



This appliance complies with the following E.E.C. Directives:
 - 73/23 EEC of 19.2.73 (Low Voltage Directive) and subsequent modifications;
 - 89/336 EEC of 3.5.89 (Electromagnetic Compatibility Directive) and subsequent modifications.

Unpacking

 All transit bolts and packing must be removed before using the appliance.

You are advised to keep all the packaging for re-use in case the machine is to be transported again.

Using a spanner unscrew and remove the rear right bolt. Lay the machine gently on its back, making sure that the hoses are not squashed.

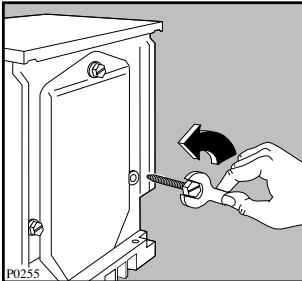

Remove the polystyrene base and take off the bottom panel by unscrewing the central screw. Carefully slide out the right polythene bag.

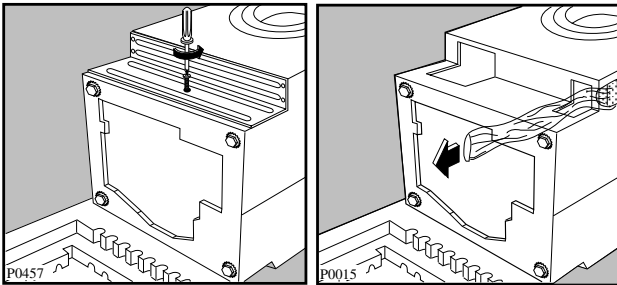

Repeat the operation for the left and central polythene bags.

Re-fit the bottom panel using the 4 screws supplied with the door hinges (in the plastic bag) and the previously removed screw.

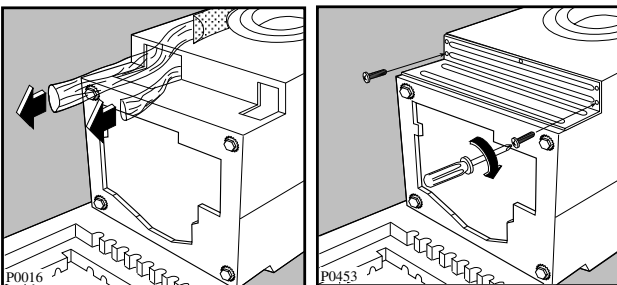

Set the machine upright and remove the two remaining bolts from the back.

Pull out the three plastic spacers from the holes into which the bolts were fitted.

Plug the open holes with the plugs which you will find in the envelope containing the instruction booklet.

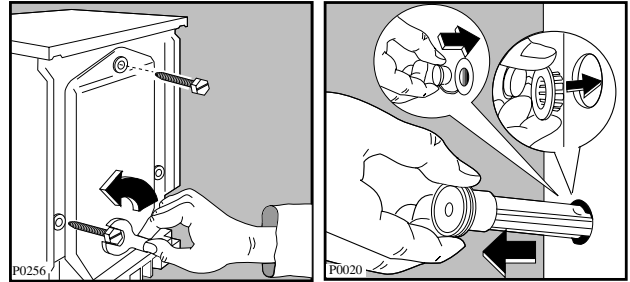

Positioning

Install the machine on a flat hard floor.

Make sure that air circulation around the machine is not impeded by carpets, rugs etc. Check that the machine does not touch the wall or other kitchen units.

Never place cardboard, wood or similar materials under the machine to compensate for any unevenness in the floor.

Your new machine has been designed to be permanently plumbed in to your home's water supply and drainage system. However, if this is not possible, it may be connected to suitable existing taps with the drain hose discharging into a sink.

The appliance has two inlet hoses, hot and cold, with female 3/4" BSP thread connectors. If this connection is not compatible with the plumbing of the existing installation, a variety of connectors are available from good hardware stores and plumbers merchants to suit most domestic plumbing. Any alteration to your existing plumbing must be carried out by a competent person, or qualified plumber.

Water inlet

The inlets on the back of the appliance are colour coded, blue for cold and red for hot.

Connect the hoses to taps with a 3/4" thread.

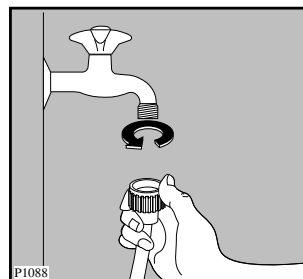

If only a cold water supply is available, connect the two hoses to a cold water outlet by means of a «Y» connection piece.

Installation should comply with local water authority and building regulations' requirements.

The appliance must be given a separate cold water supply and not be connected to a mixer tap, a single outlet water heater or a booster pump. A minimum water pressure of 0.48 bar is required for safe operation of the appliance.

If you cannot make the cold water connection direct from the rising mains, you may be able to operate the appliance from your cold water storage system.

There should be a minimum distance of 5.02m (16½ ft) between the appliance's inlet and the bottom of the water storage tank.

There will be sufficient pressure for the hot water supply, providing there is a minimum height of 2.74 metres (9 ft) between the bottom of the cold water storage tank and the bottom of the hot water cylinder.

Set the hoses correctly by loosening the ring nuts. After positioning the inlet hoses, be sure to tighten the ring nuts again to prevent leaks.

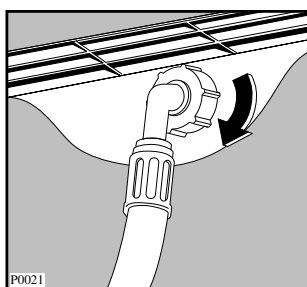

Water drainage

This appliance is designed to be permanently plumbed into your home's water supply and drainage system.

The appliance drain hose should hook into a standpipe, the hook in the drain hose is formed using the plastic «U-Piece» supplied.

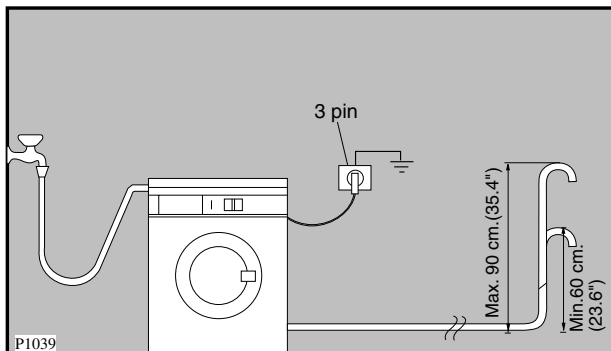

The standpipe should have an internal diameter of approximately 38mm (see diagram) thus ensuring there is an air break between the drain hose and standpipe.

When discharging into a standpipe ensure that the top of the curve in the hose end is no more than 90cm (35.4") and no less than 60cm (23.6") above floor level. The upright standpipe should have a minimum length of 30cm (12") from the bottom of the elbow to the top of the pipe (see diagram).

Make sure that it is designed in such a way, that the end of the drain hose cannot be covered with water.

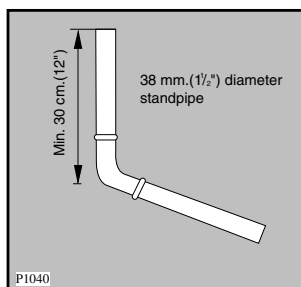

The drain hose may be extended to a maximum of 4 metres. An additional drain hose and joining piece is available from your local Service Force Centre. The joining piece must have an internal diameter of 18mm.

If you intend the drain hose to empty into a sink, make sure that the sink is empty and the plug hole is not blocked. Use the plastic «U-Piece» supplied.

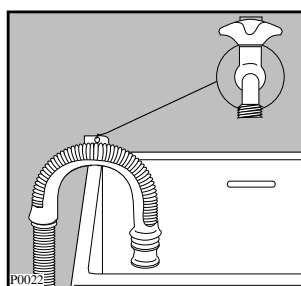

Important

Before connecting up the machine to new pipework or to pipework that has not been used for some time, run off a reasonable amount of water to flush out any debris that may have collected in the pipes.

Levelling

Level the washing machine by raising or lowering the feet. The feet may be tight to adjust as they incorporate a self locking nut, but the machine **MUST** be level.

Any necessary adjustment can be made with a spanner. Accurate levelling prevents vibration, noise and displacement of the machine during operation.

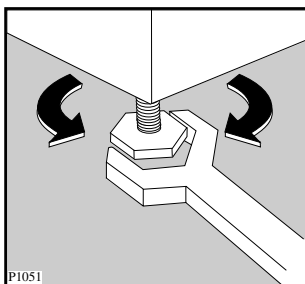

Some vibration is inevitable, especially if mounted on a wooden floor.

Sprung wooden floors are particularly susceptible to vibration. For advice, consult a builder. If possible, always place the machine on a solid floor.

Special conditions

If the floor is carpeted or covered with crumbly or soft material, insert a rigid support base under the feet to prevent noise, vibration or displacement. The base should protrude a few centimetres beyond the edges of the machine.



Warning

The machine should **NOT** be placed on deep pile carpeting.

Note

Please ensure that when the appliance is installed it is easily accessible for the engineer in the event of a breakdown.

In the interest of the environment

Washing machines and dishwashers should be connected to the FOUL drainage system, the water will then be taken to a sewage works for treatment before being discharged safely into a river.

It is essential that these appliances are not connected to the surface water drainage system as this water is discharged directly into a river or stream and may cause pollution.

If you require any further advice please contact your local authority drainage department.

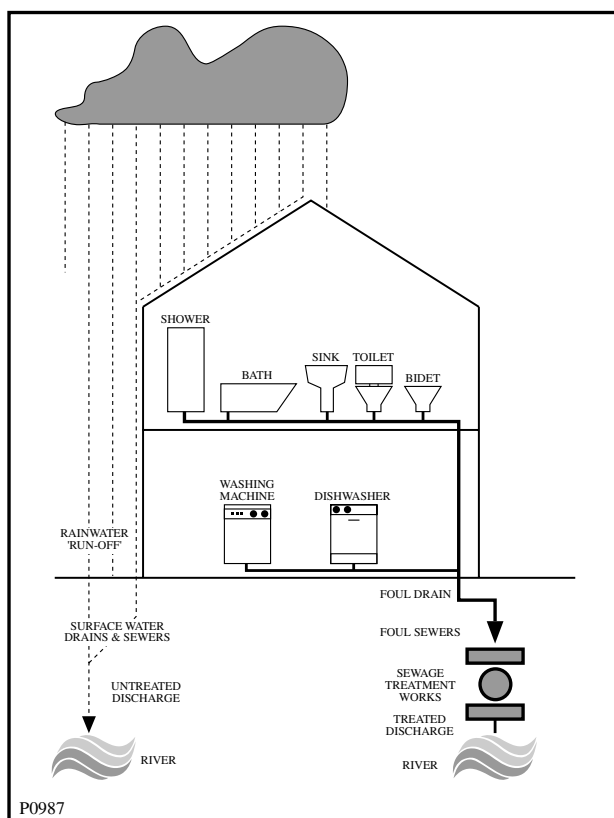

Electrical connection

Any electrical work required to install this appliance should be carried out by a qualified electrician or competent person.

WARNING: THIS APPLIANCE MUST BE EARTHED.

The manufacturer declines any liability should this safety measure not be observed.

Before switching on, make sure the electricity supply voltage is the same as that indicated on the appliance's rating plate. The rating plate is located at the top of the rim of the open door.

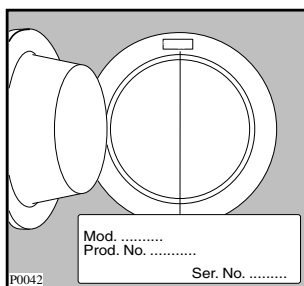

The appliance is supplied with a 13amp plug fitted. In the event of having to change the fuse in the plug supplied, a 13amp ASTA approved (BS1363 A) fuse must be used.

Should the plug need to be replaced for any reason, proceed as described below.

The wires in the mains lead are coloured in accordance with the following code:

Green and Yellow - Earth

Blue - Neutral

Brown - Live

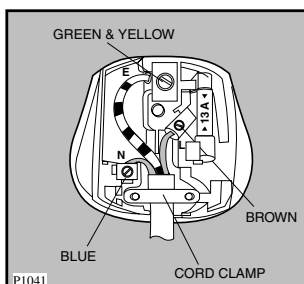

The wire coloured green and yellow must be connected to the terminal marked with the letter «E» or by the earth symbol \perp or coloured green and yellow.

The wire coloured blue must be connected to the terminal «N» or coloured black.

The wire coloured brown must be connected to the terminal marked «L» or coloured red.

Upon completion there must be no cut, or stray strands of wire present and the cord clamp must be secure over the outer sheath.



WARNING:

A cut off plug inserted into a 13 amp socket is a serious safety (shock) hazard. Ensure that the cut off plug is disposed of safely.

Should the appliance power supply cable need to be replaced, this should be carried out by our Service Force Centre.

The power supply cable must be easily accessible after installing the appliance.

Permanent connection

In the case of permanent connection it is necessary that you install a double pole switch between the appliance and the electricity supply (mains), with a minimum gap of 3mm between the switch contacts and of a type suitable for the required load in compliance with the current electrical regulations.

The switch must not break the yellow and green earth cable at any point.

Building-in

This appliance has been designed to be built into the kitchen furniture.

The recess should have the dimensions shown in picture A.

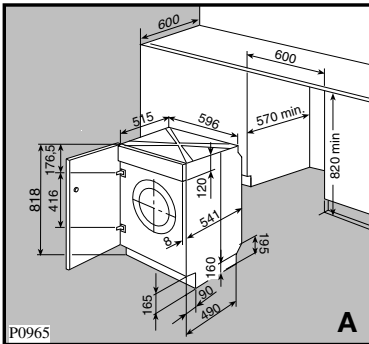

Preparation and assembly of the door

The machine is originally pre-arranged for the assembly of a door opening from right to left.

In this case it is sufficient to screw in the hinges (1) and the counter-magnet (6) provided with the appliance, at the right level (Fig. B).

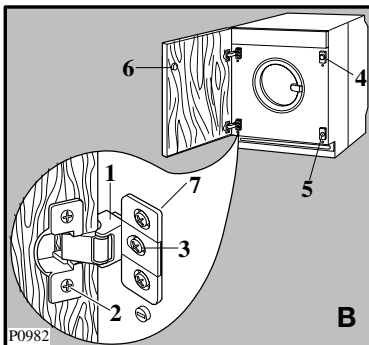

a) Door

The dimensions of the door should be:

- width 595-598 mm
- thickness 16-22 mm

The height (C-Fig. C) depends on the height of the adjacent furniture's base.

b) Hinges

To mount the hinges it is necessary to drill two holes (dia. 35 mm, depth 12.5-14 mm depending on the depth of door furniture) on the inner side of the door. The distance between the holes hobs fixing centres must be 416 mm.

The distance (B) from upper edge of the door to the centre of the hole depends on the adjacent furniture's dimensions.

The required dimensions are given in the picture C.

The hinges will be fixed to the door by means of screws for wood (2-Fig. B) supplied with the appliance.

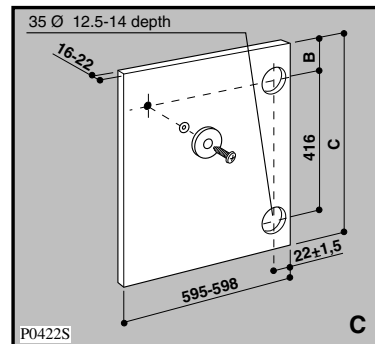

c) Mounting the door

Fix the hinges (1) to the machine by means of the M5x8 screws (3-Fig. B). The hinges can be adjusted to compensate for possible uneven thickness of the door. To align the door perfectly it is necessary to loosen the screw (3-Fig. B), adjust the door and tighten the screw again.

d) Counter-magnet (6)

The appliance is pre-arranged for a magnetic closure of the door. To enable a correct operation of this device, it is necessary to screw the counter-magnet (6) (steel disk + rubber ring) into the inner side of the door.

Its position must correspond to the magnet (4) on the appliance (see picture D).

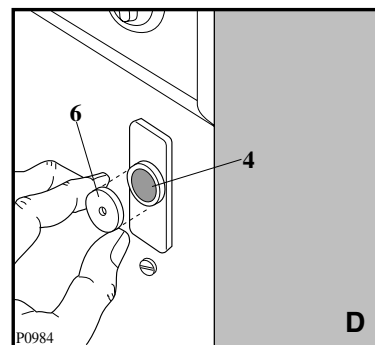

If the door has to be opened from left to right, invert the position of the plates (7), the magnet (4) and the plate (5) (Fig. B and E). Mount the counter magnet (6) and the hinges (1) as previously described.

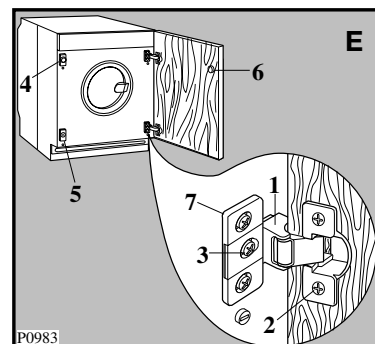

Recommendations regarding the construction and fitting of a base when the installation requires an integrated appliance to be raised

Where the appliance has been raised by mounting onto a wooden base provided by the installer. The material used to construct the base should have a non slip surface, be water repellent and if possible be one solid piece.

If it is not possible to use one solid piece, due to the additional height required, ensure that any additional strips of timber are glued and screwed to the underside of the base (see Fig. F).

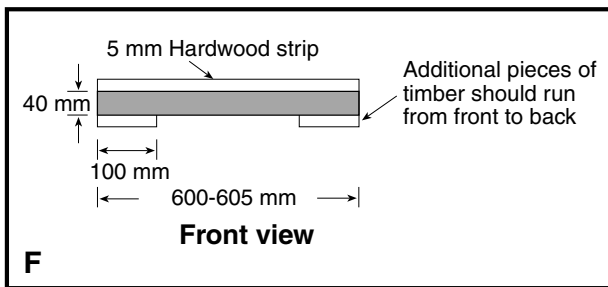

Drill four fixing holes see Fig. G

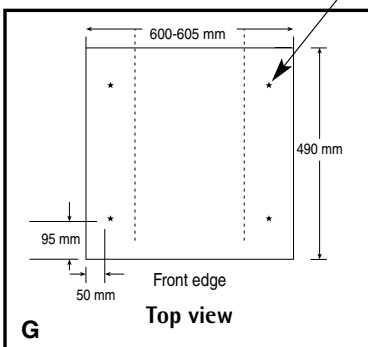

Position the base into the recess with its front edge as far forward as the adjoining plinth line will allow. **The reason for placing the base in this position is to allow a small strip of beading to be fitted in front of the appliance feet.**

Fix the base firmly to the floor using four appropriate countersunk screws (see Fig. H).

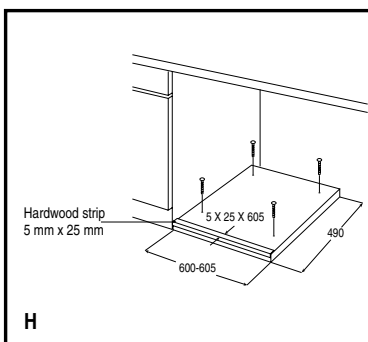

With the appliance installed adjust all four feet ensuring the machine is stable, and a clearance of approximately 5 mm is left between the top of the machine and the underside of the worktop.

A final check for stability should be carried out with the machine on spin with a load, this will identify the need for any further fine adjustment to the feet.

A strip of beading approximately 605 mm W, x 5 mm H, x 25 mm D must be screwed down into the base directly in front of the machine's feet, this will provide additional security.

If required an additional door magnet, part number 1242394-00/3 and disc, part number 1242393-00/5 are available from spare parts.

 **From the Electrolux Group. The world's No. 1 choice.**

The Electrolux Group is the world's largest producer of powered appliances for kitchen, cleaning and outdoor use. More than 55 million Electrolux Group products (such as refrigerators, cookers, washing machines, vacuum cleaners, chain saws and lawn mowers) are sold each year to a value of approx. USD 14 billion in more than 150 countries around the world.